



Standard cylinder——NSU Series

Compendium of NSU Series

NFPA Standard cylinder

Bore size: 1-1/2", 2", 2-1/2", 3-1/4", 4", 5"

No tie rod cylinder

The cylinder barrel is "Mickey Mouse" shape, and have good corrosion.

Convenient and fast fix sensor switch

Sensor can be directly fixed onto the groove of the cylinder, which is convenient and fast. the counterpart sensor type is: CMSG、DMSG(S)

Four kinds of cylinder joints

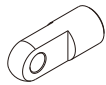

I Knuckle



Y Knuckle

Multi-mounting accessories

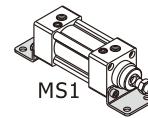

MS1

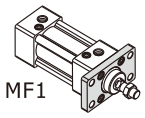

MF1

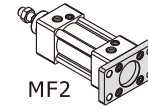

MF2

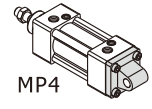

MP4

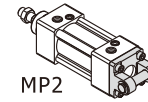

MP2

Multi-type cylinder



NSU: Double acting type



NSUD: Double rod type

Adjustable air buffer

With adjustable air buffer on the front and back cover

Installation and application



1. When load changes in the work, the cylinder with abundant output capacity shall be selected.
2. Relative cylinder with high temperature resistance or corrosion resistance shall be chosen under the condition of high temperature or corrosion.
3. Necessary protection measure shall be taken in the environment with higher humidity, much dust or water drops, oil dust and welding dregs.
4. Dirty substances in the pipe must be eliminated before cylinder is connected with pipeline to prevent the entrance of particles into the cylinder.
5. The medium used by cylinder shall be filtered to 40μm or below.
6. Anti-freezing measure shall be adopted under low temperature environment to prevent moisture freezing.
7. The cylinder shall be carried out test run without load before application. Prior to run, buffer shall be turned to the minimum and gradually released to avoid the damage on cylinder caused by excessive impact.
8. The cylinder shall avoid the influence of side load in operation to maintain the normal work of cylinder and extend the service life.
9. If the cylinder is dismantled and stored for a long time, please conduct anti-rust treatment to the surface.
Anti-dust caps shall be added in air inlet and outlet ports.



Standard cylinder

NSU Series

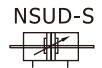
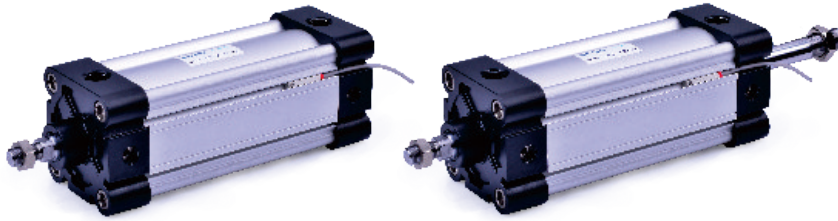

Ordering code

NSU 1-1/2 x 4 S □ T

① ② ③ ④ ⑤ ⑥

① Model	② Bore size	③ Stroke	④ Magnet	⑤ Mounting ype[Note1]	Model	⑥ Thread type
NSU: Double acting type	1-1/2"	Refer to stroke table for details	S: With magnet	Blank	NSU	T: NPT
NSUD: Double rod type	2"			MS1		
	2-1/2"	MF1				
	3-1/4"	MF2				
	4"	MP2				
	5"	MP4				
			Blank	NSUD		
			MS1			
			MF1			

[Note1] Please refer to page 228~230 for details of the accessories.

Stroke

Bore size(in)	Standard stroke (in)	Max.std stroke (in)	Max.stroke (in)
1-1/2"	1 2 3 4 5 6 8 10 12 14 16 18 20 24 28 32	48	72
2"	1 2 3 4 5 6 8 10 12 14 16 18 20 24 28 32 36 40	48	72
2-1/2"	1 2 3 4 5 6 8 10 12 14 16 18 20 24 28 32 36 40	60	72
3-1/4"	1 2 3 4 5 6 8 10 12 14 16 18 20 24 28 32 36 40	60	72
4"	1 2 3 4 5 6 8 10 12 14 16 18 20 24 28 32 36 40	60	72
5"	1 2 3 4 5 6 8 10 12 14 16 18 20 24 28 32 36 40	60	72

[Note] Consult us for non-standard stroke.

Specification

Bore size(in)	1-1/2	2	2-1/2	3-1/4	4	5
Acting type	Double acting					
Fluid	Air(to be filtered by 40μm filter element)					
Mounting type	NSU	Basic MF1 MF2 MP2 MP4 MS1				
	NSUD	Basic MF1 MS1				
Operating pressure	22~145psi(0.15~1.0MPa)					
Proof pressure	215psi(1.5MPa)					
Temperature	-5°F ~160°F (-20°C~70°C)					
Speed range in/s	1~32					
Stroke tolerance in	+0.08 0					
Cushion type	Bumper+Variable cushion					
Adjustable cushion stroke in	15/16		1-1/16		1-1/8	
Port size [Note1]	NPT3/8		NPT1/2			

[Note1] NPT thread is available. Add) Refer to P427 for detail of sensor.

Standard cylinder

NSU Series

Product feature

1. Standard cylinder manufactured by NFPA Standard.
2. The seal of piston adopts heterogeneous two way seal structure. It's dimension is tight and it has the function of oil reservation.
3. It is no tie rod cylinder. The cylinder barrel is "Mickey Mouse" shape, and have good corrosion.
4. The buffer adjustment of cylinder is smooth and steady.
5. Various specifications of cylinder and cylinder installation accessories are available for customers to choose.

Dimensions

NSU

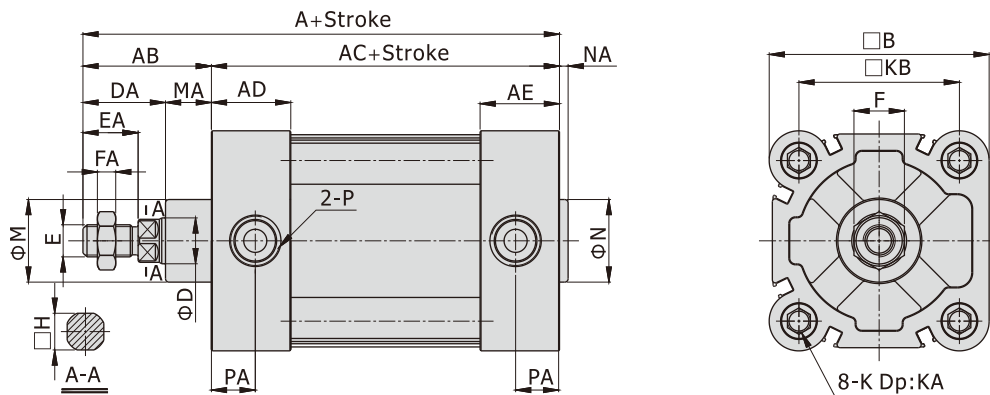

[Unit:inch]

Bore size\Item	A	AB	AC	AD	AE	B	D	DA	E	EA	F	FA	M	MA	H	K	KA
1-1/2	5-3/8	1-3/4	3-5/8	1.08	1.08	2	5/8	1-1/8	7/16-20	3/4	11/16	1/4	1-1/8	5/8	1/2	1/4-28	0.59
2	5-3/8	1-3/4	3-5/8	1.08	1.08	2-1/2	5/8	1-1/8	7/16-20	3/4	11/16	1/4	1-1/8	5/8	1/2	5/16-24	0.59
2-1/2	5-1/2	1-3/4	3-3/4	1.08	1.08	3	5/8	1-1/8	7/16-20	3/4	11/16	1/4	1-1/8	5/8	1/2	5/16-24	0.59
3-1/4	6-3/4	2-1/2	4-1/4	1.28	1.28	3-3/4	1	1-5/8	3/4-16	1-1/8	1-1/8	27/64	1-1/2	7/8	7/8	3/8-24	0.67
4	6-3/4	2-1/2	4-1/4	1.28	1.28	4-1/2	1	1-5/8	3/4-16	1-1/8	1-1/8	27/64	1-1/2	7/8	7/8	3/8-24	0.67
5	7	2-1/2	4-1/2	1.44	1.44	5-1/2	1	1-5/8	3/4-16	1-1/8	1-1/8	27/64	1-1/2	7/8	7/8	1/2-20	0.83

Bore size\Item	KB	N	NA	P	PA
1-1/2	1.43	1-1/8	0.12	NPT3/8	0.59
2	1.84	1-1/8	0.12	NPT3/8	0.59
2-1/2	2.19	1-1/8	0.12	NPT3/8	0.59
3-1/4	2.76	1-1/2	0.20	NPT1/2	0.69
4	3.32	1-1/2	0.20	NPT1/2	0.69
5	4.1	1-1/2	0.20	NPT1/2	0.85

NSUD

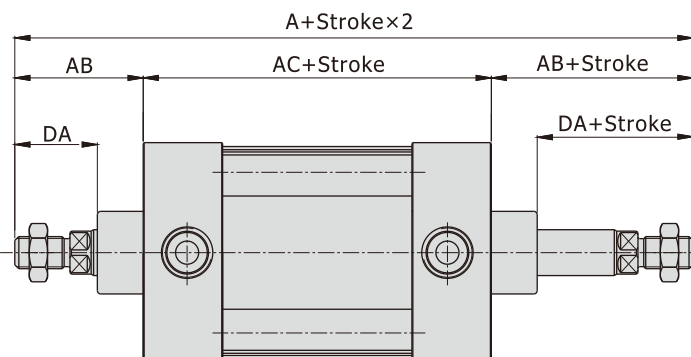

[Unit:inch]

Bore size\Item	A	AB	AC	DA
1-1/2	7-1/8	1-3/4	3-5/8	1-1/8
2	7-1/8	1-3/4	3-5/8	1-1/8
2-1/2	7-1/4	1-3/4	3-3/4	1-1/8
3-1/4	9-1/4	2-1/2	4-1/4	1-5/8
4	9-1/4	2-1/2	4-1/4	1-5/8
5	9-1/2	2-1/2	4-1/2	1-5/8

Remark: The unmarked dimension is the same as NSU standard type.

Standard cylinder

NSU Series—Accessories

List for ordering code of accessories

Accessories Bore size	Mounting accessories			
	MS1	MF1\MF2	MP2	MP4
1-1/2	F-NSU1-1/2MS1	F-NSU1-1/2MF1	F-NSU1-1/2MP2	F-NSU1-1/2MP4
2	F-NSU2MS1	F-NSU2MF1	F-NSU2MP2	F-NSU2MP4
2-1/2	F-NSU2-1/2MS1	F-NSU2-1/2MF1	F-NSU2-1/2MP2	F-NSU2-1/2MP4
3-1/4	F-NSU3-1/4MS1	F-NSU3-1/4MF1	F-NSU3-1/4MP2	F-NSU3-1/4MP4
4	F-NSU4MS1	F-NSU4MF1	F-NSU4MP2	F-NSU4MP4
5	F-NSU5MS1	F-NSU5MF1	F-NSU5MP2	F-NSU5MP4

Accessories Bore size	Knuckle		Sensor switch	
	I: I Knuckle	Y: Y Knuckle	CMSG	DMSG(S)
1-1/2	F-NSU1-1/2I	F-NSU1-1/2Y	CMSG	DMSG(S)
2	F-NSU1-1/2I	F-NSU1-1/2Y		
2-1/2	F-NSU1-1/2I	F-NSU1-1/2Y		
3-1/4	F-NSU3-1/4I	F-NSU3-1/4Y		
4	F-NSU3-1/4I	F-NSU3-1/4Y		
5	F-NSU3-1/4I	F-NSU3-1/4Y		

Accessory selection

Accessories Cylinder model	Mounting accessories					Knuckle		Sensor switch	
	MS1	MF1	MF2	MP2	MP4	I	Y	CMSG	DMSG(S)
NSU	●	●	●	●	●	●	●	●	●
NSUD	●	●	×	×	×	●	●	●	●

Material of accessories

Accessories Bore size	Mounting accessories					Knuckle	
	MS1	MF1	MF2	MP2	MP4	I	Y
1-1/2~5	<input type="checkbox"/>	<input type="checkbox"/>	<input type="checkbox"/>	<input type="checkbox"/>	<input type="checkbox"/>	<input type="checkbox"/>	<input type="checkbox"/>

—Steel

Dimensions

MS1

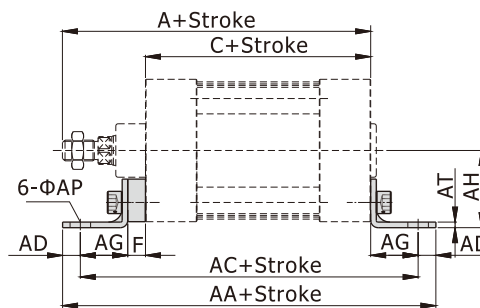
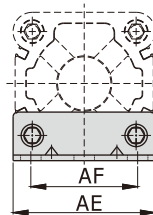

[Unit:inch]

Bore size\Item	A	C	AA	AC	AD	AE	AF	AG	AH	AP	AT	F
1-1/2	5-3/8	3-5/8	6-3/4	6	3/8	2	1-1/4	1	1.19	0.43	0.12	3/8
2	5-3/8	3-5/8	6-3/4	6	3/8	2-1/2	1-3/4	1	1.44	0.43	0.12	3/8
2-1/2	5-1/2	3-3/4	6-7/8	6-1/8	3/8	3	2-1/4	1	1.63	0.43	0.12	3/8
3-1/4	6-3/4	4-1/4	8-3/8	7-3/8	1/2	3-3/4	2-3/4	1-1/4	1.94	0.57	0.16	5/8
4	6-3/4	4-1/4	8-3/8	7-3/8	1/2	4-1/2	3-1/2	1-1/4	2.25	0.57	0.16	5/8
5	7	4-1/2	9-1/8	7-7/8	5/8	5-1/2	4-1/4	1-3/8	2.75	0.69	0.24	5/8



Standard cylinder

NSU Series—Accessories

MF1

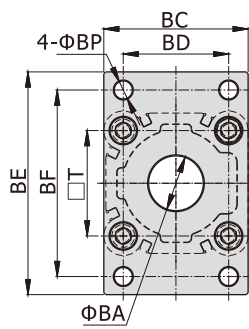
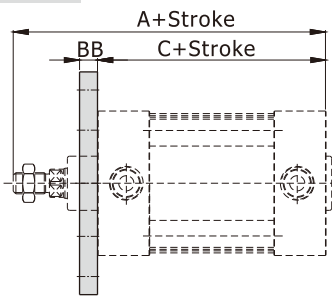

MF2

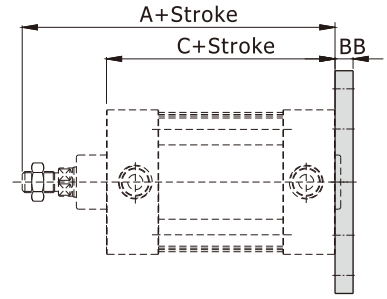
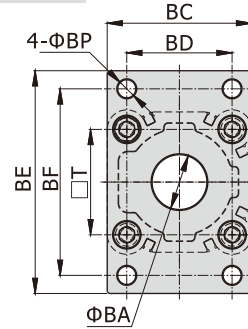

[Unit:inch]

Bore size\Item	A	C	BA	BB	BC	BD	BE	BF	BP	T
1-1/2	5-3/8	3-5/8	1-1/8	3/8	2	1.43	3-3/8	2.75	0.28	1.43
2	5-3/8	3-5/8	1-1/8	3/8	2-1/2	1.84	4-1/8	3.38	0.35	1.84
2-1/2	5-1/2	3-3/4	1-1/8	3/8	3	2.19	4-5/8	3.88	0.35	2.19
3-1/4	6-3/4	4-1/4	1-1/2	5/8	3-3/4	2.76	5-1/2	4.69	0.41	2.76
4	6-3/4	4-1/4	1-1/2	5/8	4-1/2	3.32	6-1/4	5.44	0.41	3.32
5	7	4-1/2	1-1/2	5/8	5-1/2	4.1	7-5/8	6.63	0.55	4.1

MP2

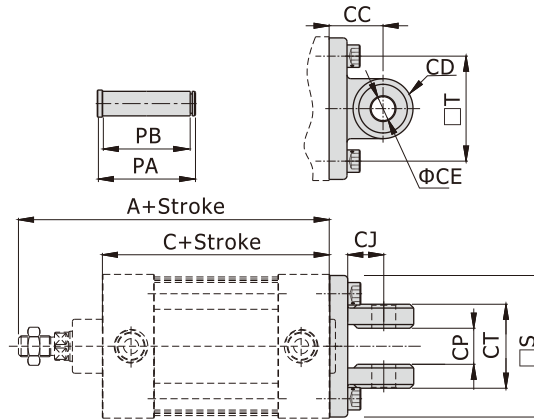

[Unit:inch]

Bore size\Item	A	C	CC	CD	CE	CJ	CP	CT	PA	PB	S	T
1-1/2	5-3/8	3-5/8	1-1/8	1/2	1/2	3/4	3/4	1-3/4	2	1.78	1.97	1.43
2	5-3/8	3-5/8	1-1/8	5/8	1/2	3/4	3/4	1-3/4	2	1.78	2.46	1.84
2-1/2	5-1/2	3-3/4	1-1/8	5/8	1/2	3/4	3/4	1-3/4	2	1.78	2.95	2.19
3-1/4	6-3/4	4-1/4	1-7/8	7/8	3/4	1-1/4	1-1/4	2-1/2	2-7/8	2.54	3.7	2.76
4	6-3/4	4-1/4	1-7/8	7/8	3/4	1-1/4	1-1/4	2-1/2	2-7/8	2.54	4.45	3.32
5	7	4-1/2	1-7/8	7/8	3/4	1-1/4	1-1/4	2-1/2	2-7/8	2.54	5.43	4.1

MP4

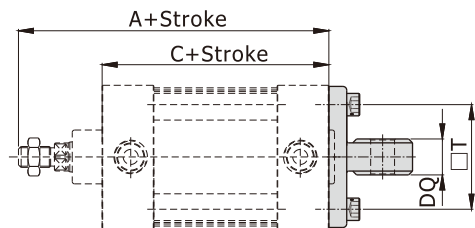

[Unit:inch]

Bore size\Item	A	C	DC	DD	DE	DJ	DQ	S	T
1-1/2	5-3/8	3-5/8	1-1/8	5/8	1/2	3/4	3/4	1.97	1.43
2	5-3/8	3-5/8	1-1/8	5/8	1/2	3/4	3/4	2.46	1.84
2-1/2	5-1/2	3-3/4	1-1/8	5/8	1/2	3/4	3/4	2.95	2.19
3-1/4	6-3/4	4-1/4	1-7/8	7/8	3/4	1-1/4	1-1/4	3.7	2.76
4	6-3/4	4-1/4	1-7/8	7/8	3/4	1-1/4	1-1/4	4.45	3.32
5	7	4-1/2	1-7/8	7/8	3/4	1-1/4	1-1/4	5.43	4.1

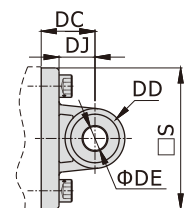

NSU Series—Accessories

I Knuckle

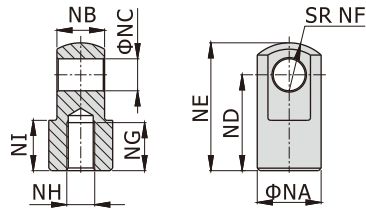

[Unit:inch]

Type\Item	NA	NB	NC	ND	NE	NF	NG	NH	NI
F-NSU1-1/2I	1	3/4	1/2	1-1/2	2	0.79	3/4	7/16-20UNF	0.79
F-NSU3-1/4I	1-1/2	1-1/4	3/4	2-1/16	2-13/16	1.18	1-1/8	3/4-16UNF	0.98

Y Knuckle

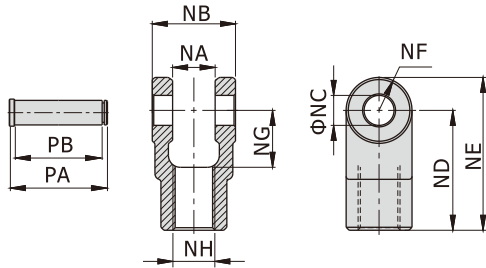

[Unit:inch]

Type\Item	NA	NB	NC	ND	NE	NF	NG	NH	PA	PB
F-NSU1-1/2Y	3/4	1-3/4	1/2	1-1/2	2	1/2	3/4	7/16-20UNF	2	1.78
F-NSU3-1/4Y	1-1/4	2-1/2	5/8	2-3/8	3-1/8	3/4	1-1/4	3/4-16UNF	2-7/8	2.54